

COMPRESSION PLATENS

2501 Series



The compression platens are used to perform compression tests on a wide range of materials and components. This allows a variety of tests to be performed for determination of compression modulus, compression strength, and compression yield strength.

Easy to install, these compression platens are precisely machined fixtures that are designed for even distribution of compression loads during a test. Spherical seating is available for applications that require self-alignment of the compression platens. To aid the operator on larger diameter anvils, laser etched circles on the platen surface allows for easier centering of the specimen body.

On the edge of the platen is a provision for the attachment of optional displacement transducers, allowing you to measure the direct displacement between two equal sized platens during a compression test.

PRINCIPLE OF OPERATION

The compression fixture has been designed to easily provide the capability of compression. Platens are rigidly fixed and are non self-aligning. They have a high stiffness that resists off center loads, which retains the parallelism during specimen failure. Universal spherical seating is designed for use with compression anvils to ensure that loading is concentrically and evenly applied to specimens that do not stand perpendicular to the platen surface.

APPLICATION RANGE

- Type of loading: Static compression, compression-compression cyclic tests
- Specimen material: Foam, plastic, metals, alloys, packaging, wood, composites, ceramics and other materials
- Specimen shapes: Square, cylindrical cubes, components

FEATURES AND BENEFITS

- A range of different diameter sizes and load rated capacities are available
- Conforms to ISO, ASTM, DIN and many other standards
- 150mm to 300mm (5.9 in to 11.8 in) diameter platens are laser etched with concentric rings for accurate specimen placement
- Optional spherical seating for concentric and evenly applied load
- Provision for attachment of optional displacement transducers
- Rugged design for minimum maintenance
- Temperature range: -150 °C to 300 °C (-238 °F to 572 °F)

PLATENS WITH LVDT MOUNTING HOLES

Catalog Number	Load Capacity			Diameter (A)		Effective Length (B)		Concentric Rings	Fitting	Weight	
	kN	kgf	lbf	mm	in	mm	in			kg	lb
2501-083	10	1,000	2,250	50	2	49	1.9	No	6 mm Pin (Type 0m)	0.41	0.9
2501-085	10	1,000	2,250	150	6	49	1.9	Yes	6 mm Pin (Type 0m)	3.5	7.5
2501-162	100	10,000	22,500	50	2	75	3	No	0.5 in Pin (Type Dm)	1	2.2
2501-163	100	10,000	22,500	150	6	75	3	Yes	0.5 in Pin (Type Dm)	4.1	9
2501-082	100	10,000	22,500	50	2	69	2.7	No	16 mm Pin (Type 1m)	1	2.2
2501-084	100	10,000	22,500	150	6	69	2.7	Yes	16 mm Pin (Type 1m)	4.1	9
2501-089	100	10,000	22,500	50	2	50	2	No	M30 × 2 Male LH (Type Im)	1	2.2
2501-071	100	10,000	22,500	150	6	50	2	Yes	M30 × 2 Male LH (Type Im)	7	15.4
2501-116	300	30,000	67,500	75	3	50	2	Yes	M48 × 2 Male LH (Type II m)	5.6	12.3
2501-117	300	30,000	67,500	150	6	50	2	Yes	M48 × 2 Male LH (Type II m)	8	17.6
S1-12093-1	600	60,000	135,000	127	5	63.5	2.5	Yes	M72 × 3 Male LH (Type II Am)	7.9	17.5

PLATENS WITHOUT LVDT MOUNTING HOLES

Catalog Number	Load Capacity			Diameter (A)		Effective Length (B)		Concentric Rings	Fitting	Weight	
	kN	kgf	lbf	mm	in	mm	in			kg	lb
2501-108	0.05	5	11	57	2.25	35	1.4	No	6 mm Pin (Type 0m)	0.1	0.21
2501-114	0.1	10	22	50	2	21	0.8	No	2.5 mm Pin (Type 00m)	0.05	0.1
S1-11585	0.1	10	22	150	6	113	4.4	Yes (Grooved)	2.5 mm Pin (Type 00m)	0.6	1.35
2501-104	10	1,000	2,250	40.6	1.6	47.5	1.9	No	6 mm Pin (Type 0m)	0.272	0.6
2501-121	10	1,000	2,250	57	2.25	47.5	1.9	No	6 mm Pin (Type 0m)	0.5	1.1
2501-106	10	1,000	2,250	128	5	47.5	1.9	No	6 mm Pin (Type 0m)	2.5	5.5
2501-080	10	1,000	2,250	254	10	19	0.75	No	4 × M10 (90 × 280)	12	26
S1-12093-2	600	60,000	135,000	203	8	63.5	2.5	Yes	M72 × 3 Male LH (Type II Am)	17.7	39

Notes:

1. Temperature Range: -150 °C to 300 °C (-238 °F to 572 °F)
2. Hardness (HRC): 56-58
3. Concentric rings are laser etched with negligible change in the surface roughness, except where noted
4. 2501-080 is a 305 × 254 mm plate, bolts to the base of the frame

ACCESSORIES

Catalog Number	Rated Capacity		Mechanical Fitting	Accessory Fitting	Weight	
	kN	lb			kg	lb
2501-096	100	22,500	M10 × 6 on 100 PCD	M10 × 6 on 100 PCD	7	15.4
2501-118	300	67,500	M10 × 6 on 100 PCD	M48 × 2 (Type II)	12	26.5
2601-071	LVDT platen displacement fixture, including 100 mm (4 in) and 150 mm (6 in) adjustable targets. Mounts directly on the side of the platen.					

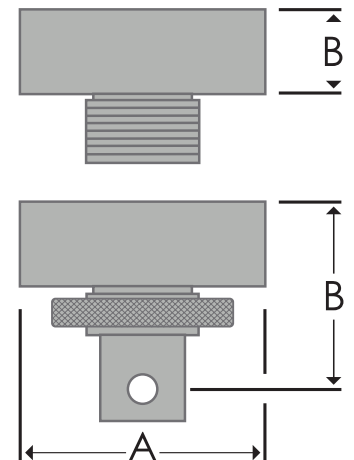

www.instron.com



Worldwide Headquarters
825 University Ave, Norwood, MA 02062-2643, USA
Tel: +1 800 564 8378 or +1 781 575 5000

European Headquarters
Coronation Road, High Wycombe, Bucks HP12 3SY, UK
Tel: +44 1494 464646